

目录

使用注意事项	1
外形及部件名称	2
安装说明	3
运行状况与参数调整	4
流量报警与输出端口	8
技术参数	9
简单故障处理	10

SIMPIE TROUBLESHOOTING

FAILURE	FAULT CAUSE	APPROACH
Machine turned on but unenergified	Power cord is not plugged in place	Check and ensure the power interface and the power plug is plugged in place and in good contact.
	Fuse burnt-out	Pull out the fuse box from the power supply interface of the chiller, check the fuse, replace with spare fuse if necessary and check whether the power supply voltage is stable; Check and ensure the power interface and the power plug is plugged in place and in good contact
Flow Alarm (panel red light is on)use a water pipe directly connect to the water outlet and inlet but still without water flowing	Water level in the storage water tank is too low	Check the water level gauge display, add water until the level shown in the green area; And check whether water circulation pipe leaks
	Water circulation pipes are blocked or a pipe bending deformation	Check water circulation pipe
Ultra-high temperature alarm	Blocked dust gauze, bad thermolysis	Unpick and wash the dust gauze regularly
	Poor ventilation for air outlet and inlet	To ensure a smooth ventilation for air outlet and Inlet
	Voltage is extremely low or astable	To improve the power supply circuit or use a voltage regulator
	Improper parameter settings on thermostat	To reset controlling parameters or restore factory settings
	Switch the power frequently	To ensure there is sufficient time for refrigeration(more than 5 minuets)
	Excessive heat load	Reduce the heat load or use other model with larger cooling capacity
Alarm for ultra-high room temperature	The working ambient temperature is too high for the chiller	To improve the ventilation to guarantee that the machine is running under 40°C
Serious problem of condensate water	Water temperature is much lower than ambient temperature, with high humidity	Increase water temperature or to preserve heat for pipeline
Water drains slowly from outfall during water changing	Injection port is not open	Open the injection port

PACKING LIST

- 1.1 unit of industrial chiller.
- 2.1 copy of user manual.
- 3.1 pc of power cord.
- 4.1 pc of connection hose.
- 5.2 pcs of sealed hoop.
- 6.1 pc of alarm signal output plug
- 7.1 pc of spare fuse.

(Held in the spare fuseholder of power socket.)

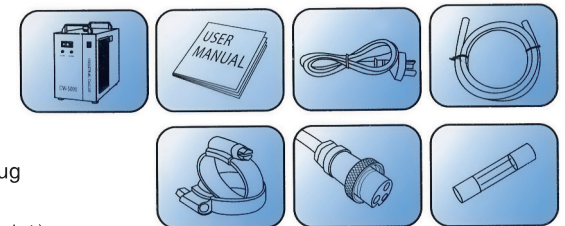

SPECIFICATIONS

CW-5000 Series compressional type chiller

MODEL	CW-5000AG	CW-5000BG	CW-5000DG	CW-5000AI	CW-5000BI	CW-5000DI	CW-5000AK	CW-5000BK	CW-5000DK
Voltage	AC220 ~ 240V	AC208 ~ 230V	AC100 ~ 110V	AC220 ~ 240V	AC208 ~ 230V	AC100 ~ 110V	AC220 ~ 240V	AC208 ~ 230V	AC100 ~ 110V
Frequency	50Hz	60Hz	60Hz	50Hz	60Hz	60Hz	50Hz	60Hz	60Hz
Current	1.4 ~ 2.1A		3.5 ~ 5.6A	1.4 ~ 2.1A		3.5 ~ 5.6A	1.4 ~ 2.1A		3.5 ~ 5.6A
Compressor power	0.295KW	0.38KW	0.305KW	0.295KW	0.38KW	0.305KW	0.295KW	0.38KW	0.305KW
	0.40HP	0.52HP	0.41HP	0.40HP	0.52HP	0.41HP	0.40HP	0.52HP	0.41HP
Refrigeration capacity	2361Btu/h	2999Btu/h	2866Btu/h	2361Btu/h	2999Btu/h	2866Btu/h	2361Btu/h	2999Btu/h	2866Btu/h
	0.692KW	0.879KW	0.84KW	0.692KW	0.879KW	0.84KW	0.692KW	0.879KW	0.84KW
	595Kcal/h	756Kcal/h	722Kcal/h	595Kcal/h	756Kcal/h	722Kcal/h	595Kcal/h	756Kcal/h	722Kcal/h
Refrigerant	R-134a								
Refrigerant charge	300g	320g	280g	300g	320g	280g	300g	320g	280g
Precision	±0.3℃								
Reducer	Capillary								
Protection	Over current protection for compressor, flow alarm, over temperature alarm								
Pump power	0.03KW			0.1KW			0.05KW		
Tank capacity	6L								
Inlet and outlet	External Φ10mm brass connector					Internal Φ8mm speedy connector			
Max.Lift	10M			25M			70M		
Max.Flow	10L/min			16L/min			2L/min		
N.W	26Kgs			29Kgs			29Kgs		
G.W	31Kgs			34Kgs			34Kgs		
Dimension	55*28*43cm(L*W*H)								
Package dimension	72*44*62cm(L*W*H)								

*With heating and higher temperature control precision functions are optional.

CW-5200 Series compressional type chiller

MODEL	CW-5200AG	CW-5200BG	CW-5200DG	CW-5200AI	CW-5200BI	CW-5200DI	CW-5200AK	CW-5200BK	CW-5200DK
Voltage	AC220 ~ 240V	AC208 ~ 230V	AC100 ~ 110V	AC220 ~ 240V	AC208 ~ 230V	AC100 ~ 110V	AC220 ~ 240V	AC208 ~ 230V	AC100 ~ 110V
Frequency	50Hz	60Hz	60Hz	50Hz	60Hz	60Hz	50Hz	60Hz	60Hz
Current	2.4 ~ 3.1A	2.6 ~ 3.3A	4.5 ~ 6.5A	2.4 ~ 3.1A	2.6 ~ 3.3A	4.5 ~ 6.5A	2.4 ~ 3.1A	2.6 ~ 3.3A	4.5 ~ 6.5A
Compressor power	0.52KW	0.5KW	0.68KW	0.52KW	0.5KW	0.68KW	0.52KW	0.5KW	0.68KW
	0.71HP	0.68HP	0.93HP	0.71HP	0.68HP	0.93HP	0.71HP	0.68HP	0.93HP
Refrigeration capacity	5084Btu/h	4982Btu/h	5186Btu/h	5084Btu/h	4982Btu/h	5186Btu/h	5084Btu/h	4982Btu/h	5186Btu/h
	1.49KW	1.46KW	1.52KW	1.49KW	1.46KW	1.52KW	1.49KW	1.46KW	1.52KW
	1281Kcal/h	1256Kcal/h	1307Kcal/h	1281Kcal/h	1256Kcal/h	1307Kcal/h	1281Kcal/h	1256Kcal/h	1307Kcal/h
Refrigerant	R-22/R134a/r-410a								
Refrigerant charge	360g	380g	350g	360g	380g	350g	360g	380g	350g
Precision	±0.3℃								
Reducer	Capillary								
Protection	Over current protection for compressor, flow alarm, over temperature alarm								
Pump power	0.03KW			0.1KW			0.05KW		
Tank capacity	6L								
Inlet and outlet	External Φ10mm brass connector					Internal Φ8mm speedy connector			
Max.Lift	10M			25M			70M		
Max.Flow	10L/min			16L/min			2L/min		
N.W	30Kgs			33Kgs			33Kgs		
G.W	35Kgs			38Kgs			38Kgs		
Dimension	55*28*43cm(L*W*H)								
Package dimension	72*44*62cm(L*W*H)								

*With heating and higher temperature control precision functions are optional.

感谢您购买本产品，请在使用前仔细阅读使用安装说明书，并妥善保管。

本使用安装说明书并非质量保证书，对印刷错误的更正，所述信息错误的勘误，以及产品的改进，均由制造商随时做出解释，恕不预先通知，修正内容将编入再版使用安装说明书中。

使用注意事项

① 请确保电源插座接触良好并且地线可靠接地!

虽然冷水机的平均工作电流不大，但是其瞬时工作电流有时高达6~10安培（AC110V电源机型瞬时工作电流有时高达10~15安培）。

② 请确保冷水机的工作电压稳定、正常!

由于制冷压缩机对电源电压比较敏感，我公司标准产品的正常工作电压为200~250V（110V机型为100~130V）。如果确实需要更宽的工作电压范围，可以另行定制。

③ 电源频率不匹配会导致机器损坏!

请根据实际情况，使用50Hz或60Hz的机型。

④ 为保护循环水泵，严禁无水运行!

新机装箱前都排空了储水水箱，请确保水箱注入足够水后再开机，不然水泵极易损坏。当水箱水位在水位计绿色（NORMAL）范围以下时，冷却机制冷量会轻微下降，请保证水箱水位在水位计的绿色（NORMAL）范围内。严禁使用循环泵排水！

⑤ 请确保冷水机入风、出风通道顺畅!

冷水机后面的出风口距离障碍物要留有30cm以上的距离，侧面的入风口离障碍物要求距离在8cm以上。

⑥ 入风口的滤网必须定期清洗!

必须定期拆洗防尘网，防尘网严重堵塞会引起冷水机故障。

⑦ 请注意冷凝水的影响!

当水温低于环境温度，并且环境湿度较大时，循环水管与被冷却器件表面会产生冷凝水。当出现以上情况时，建议调高水温设定或者对连接水管及被冷却器件保温。



注意：本产品为工业设备，请勿让儿童玩耍！

外形及部件名称

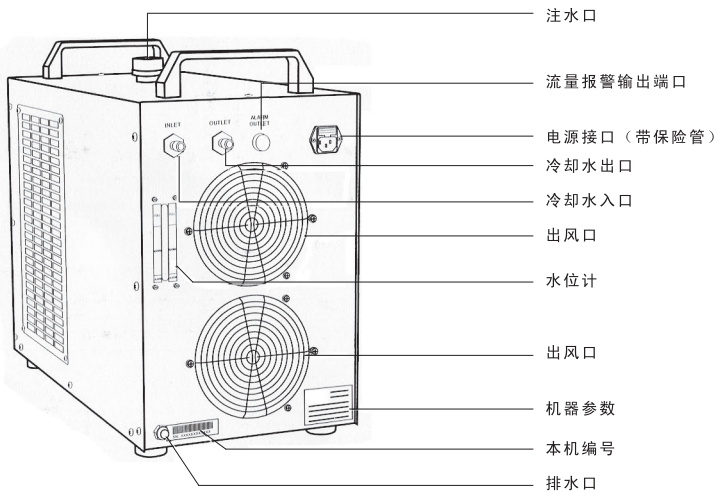
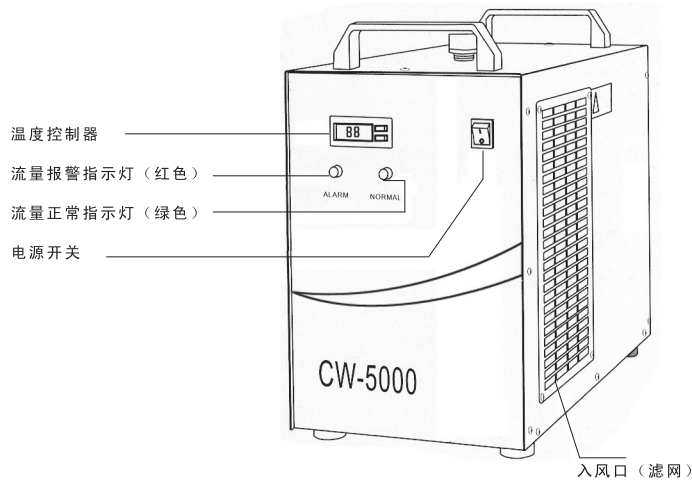

Flow alarm and output ports

In order to guarantee the equipment will not be damaged while cooling water circulation is out of control, CW-5000/5200 series chillers possesses an low flow alarm protection.

1.Flow alarm output ports and the wiring diagram

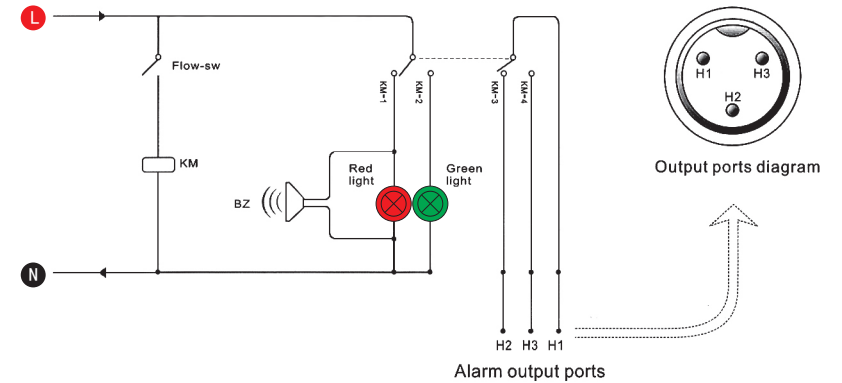

1.Flow alarm causes of circulating cooling water and working state

DISPLAY	Normal flow indicator	Flow alarm indicator	BUZZER	OUT H1、H2	OUT H1、H3
CONDITION					
Circulating pump works properly	● On	⊗ Off	⊗ No sound	● Off	● On
Blocked cooling water circulation loop	⊗ Off	● On	⊙ sounds	● On	● Off
Alarm of water shortage	⊗ Off	● On	⊙ sounds	● On	● Off
Faulted circulating pump	⊗ Off	● On	⊙ sounds	● On	● Off
Power interruption				● On	● Off

Note:The flow alarm is connected to the normally open relay and normally closed relay contacts,requiring operating current less than 5A, working voltage less than 300V.

3.Set temperature

In the temperature display condition, long press the "S" key for 2 seconds to enter into the state of temperature setting, the temperature is displayed on the digital display is the set temperature, then use the up or down button to change the setting value ("▲" key increase 0.1 °C, "▼" key minus 0.1 °C, hold on the button not more than 0.5 seconds, and then quickly increase or decrease). After setting, press "S" key to exit the setup. In the process of setting press "M" keys said to give up, quit without saving the settings value.

In the intelligent temperature mode, is set with respect to the temperature difference between room temperature (equivalent to the parameters F10); under the mode of constant temperature, is to set the absolute temperature(equivalent to the parameters F11).

4.Room temperature display

In display water temperature state, press "▼" button to view the room temperature.

5.Advanced Operations

Long press the "M" key for 5 seconds to enter into the state of temperature setting, if a command is set, it will show "PAS" words prompted for a command, enter the command using the "▲▼" button, parameter code is displayed if the command is correct, use "▲▼" button to select parameters code, select a code, then press the "S" key to display the code corresponding to the parameter values, this time use the "▲▼" key to set the parameter value, After the completion of setting and then press the "S" key to return to display the status of the parameter code. When the parameter code is displayed, press the "M" key to exit the parameter setting state, in the process of setting press "M" keys said to give up, quit without saving the settings value. The parameter code shown as the following table:

CATEGORY	CODE	PARAMETER NAME	SETTING RANGE	FACTORY SETTING	UNIT	REMARK
temperature control category	F10	Temperature difference value (relative to the room temperature)	-30.0—10.0	-2.0	°C/°F	For intelligent mode
	F11	Set temperature	F14—F13	25.0	°C/°F	For constant temperature mode
	F12	Cooling hysteresis	0.1—20	0.8	°C/°F	Refer to temperature control principle
	F13	Maximum set temperature	-58—302	30.0	°C/°F	Attention Please: Controller will be forced to maintain F14 < F11 < F13 this rules, if you find some parameters cannot be adjusted, because of its "Stand" by other parameters, need to adjust another parameter first.
	F14	Minimum set temperature	-58—302	20.0	°C/°F	
	F15	High temperature alarm temperature	1.0—30.0	10.0	°C/°F	Relative to the set temperature
	F16	Low temperature alarm temperature	1.0—30.0	15.0	°C/°F	Relative to the set temperature
	F17	Over high room temperature exhausted temperature	0—80.0	45.0	°C/°F	
	F19	Temperature sensor correction	-20—20.0	0.0	°C/°F	Corrected temperature sensor error
压机类	F21	The compressor shutdown protection time	0—10	3	分钟	
	F29	Control mode	0/1	1	-	0: Constant temperature mode 1: Intelligent mode
告警类	F57	Exhausted output mode	0—1	0	-	0: Normally open, closed when exhausted 1: Normally closed, disconnect when exhausted
系统设置类	F80	Command	OFF 0001—9999	OFF	-	OFF stands for no command Set to 0000 stands for clear the command
	F81	Temperature Units	C/F	C	-	C: CELSIUS F: FAHRENHEIT
测试类	F98	Manufacturers to retain				
	F99	Self-Test				This function will pick -up all of the relays in turn, strictly prohibited to use online.
	End	Exit Setup				

安装说明

工业冷水机安装使用非常简易，新机首次使用可以按以下步骤进行：

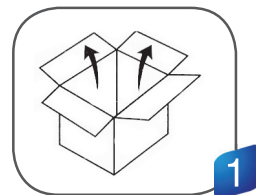

打开包装，检查机器是否完好，附件是否齐备

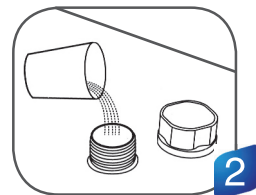

拧开机器顶部注水口

加入冷却水(注意不要让水溢出)

加水时应同时观察水位计的水位慢慢加水，注意不要让水溢出!用于碳钢材质设备的冷却时应添加适量的冷却水添加剂(防腐蚀性水剂)。北方寒冷地区使用的应该加注无腐蚀性的防冻液。

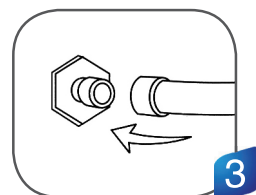

根据系统情况把出、入水管接好

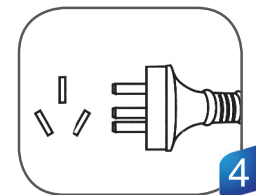

接上电源，打开电源开关
(严禁无水开机)

1. 打开电源开关后，冷水机循环泵就开始工作了。新机第一次开机时管路中会有较多的气泡导致机器偶尔流量报警，运行数分钟后就会恢复正常。
2. 第一次开机后，必须马上检查水管管路有无漏水。
3. 打开电源后，如果水温低于设定温度，机器的风扇等器件不工作是正常现象。温控器会根据设定的控制参数自动控制压缩机、电磁阀、风扇等器件的工作状态。
4. 由于压缩机等器件有一个较长的启动过程，根据不同的工况从几十秒到数分钟不等，所以不要频繁开关机。

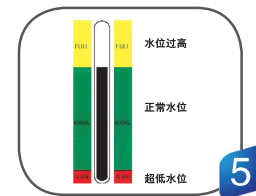

检查水箱水位

新机开机后排空了水管中的空气，水箱水位会略有下降，为了保持水位在绿色区域，可以再次适量加水。观察并记下当前的水位情况，等冷水机运行一段时间后再次观察水位计，如果水位下降明显，就要再次检查水管管路的渗漏情况。

调整温控器参数

OW-5000/5200系列冷水机使用的智能温控器一般情况下不需要调整控制参数，如确实必要的，可参考第4页《运行状况与参数调整》。

运行状况及参数调整

一、基本工作原理

1、温度控制

本控制器有智能和恒温两种温度控制模式(参数F29)

恒温模式下，温度控制点由“设定温度(F11，或长按S键设置)”和“温差(F12)”两个参数确定。当温度探头上感知到的温度高于“设定温度+温差”时启动制冷，一直到温度低于“设定温度-温差”时停止制冷。

智能模式下，温度控制原理和恒温模式类似，只是设定温度自动跟踪室温，和室温保持一个固定的差值，这个差值由参数F10设定。

2、压缩机停机延时保护

压缩机延时保护时间由参数F21设定，这里假定设为三分钟。在控制器内有一个“压缩机停机计时器”，当压缩机停机时开始时，下一次启动压缩机前首先检查这个计时器，如果已满三分钟则立即启动压缩机，如果不满三分钟则等满三分钟再启动。这样可以保证停机后再启动间隔大于三分钟，防止频繁启动损坏压缩机。另外控制器刚通电的三分钟之内也不会启动压缩机，这样在突然停电再来电的情况下也能保护压缩机。

二. MAIN FUNCTION:



Water chiller controller, intelligent and constant temperature two control modes, compressor start delay protection, high and low temperature alarm, room temperature ultra-high alarm, sensor malfunction alarm, password command, Fahrenheit Celsius conversion.

三. TECHNICAL SPECIFICATIONS:

1. Temperature range: -50 To 150 °C(resolution 0.1 °C) -58 to 302 °F (resolution 0.1 °F)
2. Supply Voltage: 220V ± 10% or 380V ± 10%, reference product posting
3. Use of the environment: temperature -10 to 50 ° C, humidity ≤ 85%, non-condensing.
4. Output capacity of electric shock: compressor 20A/250VAC, alarm 8A/250VAC (both pure resistive load)
5. Temperature sensor: NTC R25 = 5kΩ, B (25/50) = 3470K

四. OPERATION GUIDE:

1. The meaning of indicator on the panel

INDICATOR	INDICATOR NAME	BRIGHT	FLICKER
	Temperature setting	State temperature settings	-
	Refrigeration	In the refrigeration	Ready to refrigeration, in compressor delay protection status
	Alarm	-	Alarm status

2. The meaning of digital display

Digital tube display temperature in normal situation, if displays "SHr" said temperature sensor short-circuit, "OPE" said temperature sensor is disconnected, display code as following table:

ALARM CODE	IMPLICATION	INTRODUCTION
A21	Water temperature sensor failure	Water temperature sensor wire break or short circuit (Current temperature display "OPE" or "SHr")
A22	Room temperature sensor failure	Room temperature sensor wire break or short circuit
A31	High temperature alarm	
A32	Low temperature alarm	
A33	Over high room temperature alarm	

3.Command

In order to prevent the non-staff change controller parameters, can set a command(parameters F80), if you set a command by F18, when every time you long press the "M" key to enter into the setstate it will prompt you to enter a command, only you enter the correct command , you can set the parameters. If you don't need a command, can make F80 " OFF" . Pay attention to remember that after set the command if you forget your command you will not be able to enter into the setstate.

4.Exhausted output

The controller has one independent exhausted output, to exhausted output contact action when the following occurs:

- 1、 temperature probe failure
- 2、 high temperature exhausted
- 3、 low temperature exhausted
- 4、 over high room temperature exhausted

Exhausted output can be set to normally open or normally closed two modes (parameter F57) , in the normally open mode, normal operation is exhausted output contact is disconnected, contact closed when it is exhausted; in the normally closed mode, normal operation is exhausted output contact is closed, contact disconnected when it is exhausted.

3、 口令

为了防止无关人员改变控制器参数，可以设置一个口令(参数F80)，如果F80设置了一个口令，则每次长按“M”键进入设置状态时会提示输入口令，必须输入正确的口令才能设置参数。如果不需要口令，则可将F80设为“OFF”。注意设置口令后一定要记住，忘记口令将无法进入设置状态。

4、 告警输出

控制器有一路独立的告警输出，当发生下列情况时，告警输出触点动作：

- 1、 温度探头故障
- 2、 高温告警
- 3、 低温告警
- 4、 室温超高告警

告警输出可设置成常开或常闭两种模式(参数F57)，在常开模式下，正常工作时告警输出触点断开，发生告警时触点闭合；在常闭模式下，正常工作时告警输出触点闭合，发生告警时触点断开。

二、主要功能

冷水机组控制器，有智能和恒温两种控制模式，压缩机开机延时保护，高低温告警，室温超高告警，传感器异常告警，密码口令，华氏摄氏转换等。

三、技术指标

- 1、温度范围：-50~150℃(分辨率0.1℃) -58~302°F(分辨率0.1°F)
- 2、电源电压：220V ± 10%或380V ± 10%，参见产品后贴
- 3、使用环境：温度-10℃ ~ 50℃，湿度≤85%，无凝露。
- 4、输出触点容量：压缩机20A/250VAC，告警8A/250VAC(均为纯阻性负载)
- 5、温度传感器：NTC R25=5kΩ，B(25/50)=3470K

四、操作指南

1、面板上的指示灯含义

指示灯	指示灯名称	亮	闪烁
	温度设定	正在温度设置状态	-
	制 冷	正在制冷	准备制冷，在压缩机延时保护状态
	告 警	-	告警状态

2、数码管显示含义

参数码管在正常时显示温度，如果显示“SHr”表示温度传感器短路。“OPE”表示温度传感器断线。告警时交替显示温度和告警代码(Axx)。显示代码如下表：

告警代码	含 义	说 明
A21	水温传感器故障	水温传感器断线或短路(当前温度显示“OPE”或“SHr”)
A22	室温传感器故障	室温传感器断线或短路
A31	高温告警	
A32	低温告警	
A33	室温过高告警	

Operation status and parameters adjustment

—.BASIC WORKING PRINCIPLE

1.Temperature control

The controller has two kinds of intelligent and constant temperature control mode (parameter F29)

Under the mode of constant temperature, temperature control point is determined by these two parameters “set temperature(F11, or long press the S key to set)” and “temperature difference(F12)”. When the temperature probe perceived temperature is higher than “setting temperature+temperature difference” to start refrigeration, until the temperature below “set temperature- temperature difference” to stop refrigeration.

The mode of intelligent temperature control principle is similar to constant temperature mode, just set temperature automatically tracking the room temperature, keep a fixed value with room temperature, this fixed value is set by the parameter F10.

2.Compressor stop delay protection

The compressor delay protection time set by parameter F21, here assumed to be set to three minutes. The controller within a “compressor stop timer”, timing starts when the compressor stop, before starting the compressor first checks the timer next time, if three minutes is full, immediately start the compressor, if three minutes is not full, wait at least three minutes is full and then start. This ensures that the stop and then start the interval is greater than three minutes to prevent damage to the compressor frequent start. In addition, the compressor does not start in the controller just electricity within three minutes, it also can protect the compressor in the case of suddenly power off and then power on.

Installation

It's very simple to install this industrial water chiller. The installation for the first time of the new machine can be carried out by following steps:

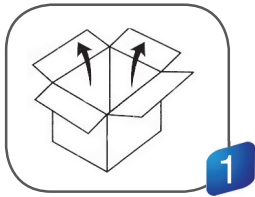

Open the package to check if the machine is intact and all the necessary accessories are completed.

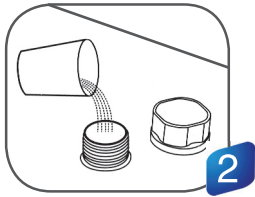

Open the injection port to feed cooling water. (Do not let the water spill over!)

Observing the water level gauge and adding water slowly, be careful not to have the water overflowed! For the cooling of carbon steel equipment, the water should be added an appropriate amount of cooling water additive (anti-corrosion water aqua). Working in cold north area, it's better to use noncorrosive antifreeze fluid.

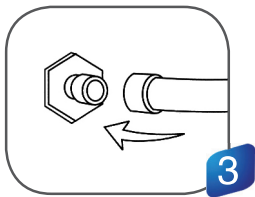

According to system conditions, please connect the water inlet and outlet pipes well.

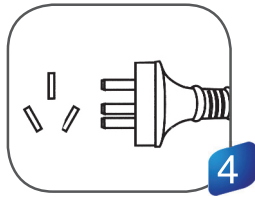

Plug in power, turn on the power switch.

(Do not start up without water in the water tank!)

- (1) Power switch turned on, the circulation pump of the chiller starts working. Then first time of operating may cause more bubbles in the pipe leading to a flow alarming occasionally, but running for a few minutes later, it will go back to normal.
- (2) After the first boot, you must immediately check whether the water pipe leaks.
- (3) Power switched on, if the water temperature is below the set figure, it is normal that fans and other components of the machine do not work. The temperature controller will automatically control the working conditions of the compressor, magnetic valve, fans and other parts based on the set controlling parameters.
- (4) As it takes a longer time to start over the compressor and other components, according to different conditions, the time is range from seconds to minutes, so do not turn off the power and again on frequently.

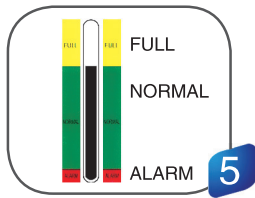

Check the water level in the water tank.

The first startup of the new chiller empties the air in the water pipe, leading a slight water level decline, but in order to keep the water level in the green area, it's allowed to add adequate water again. Please observe and record the current water level, and inspect it again after the chiller running for a period of time, if the water level drops obviously, please re-inspect the water pipeline leakage.

Adjust parameters of temperature controller.

CW 5000/5200 series use an intelligent thermostat. Normally users do not need to adjust it. If it is really necessary, please refer to page 15, "Operating status and parameters adjustment".

3、设置温度

在显示温度状态, 长按“S”键2秒, 进入温度设置状态, 这时数码显示器上显示的温度即为设定温度, 然后用上或下键改变设定值(“▲”键增0.1℃, “▼”键减0.1℃, 按住不放超过0.5秒则快速增减)。设置完成后按“S”键退出设置状态。设置过程中按“M”键表示放弃, 退出但不保存设置值。

在智能模式下, 设定的是相对于室温的温差(相当于参数F10); 在恒温模式下, 是绝对设定温度(相当于参数F11)。

4、室温显示

在显示水温状态, 按住“▼”键可查看室温。

5、高级操作

长按“M”键5秒, 进入参数设置状态, 如果设置了口令, 会显示“PAS”字样提示输入口令, 用“▲▼”键输入口令, 如果口令正确, 则会显示参数代码, 用“▲▼”键选择参数代码, 选择一个代码后按“S”键则显示该代码对应的参数值, 这时再用“▲▼”键即可对参数值进行设置, 设置完成后再按“S”键, 回到显示参数代码状态。在显示参数代码时按“M”键可退出参数设置状态, 在设置参数值过程中按“M”键表示放弃, 退出但不改变参数值。参数代码如下表所示:

类别	代码	参数名称	设定范围	出厂设定	单位	备注
温控类	F10	温差数值(相对于室温)	-30.0—10.0	-2.0	℃/F	用于智能模式
	F11	设定温度	F14—F13	25.0	℃/F	用于恒温模式
	F12	制冷回差	0.1—20	0.8	℃/F	详见温度控制原理的说明
	F13	最高设定温度	-58—302	30.0	℃/F	注意: 控制器会强制维持F14<F11<F13这一规则, 如发现某一参数不能调整, 是因为被其它参数“顶”住了, 要先调整另一个参数。
	F14	最低设定温度	-58—302	20.0	℃/F	
	F15	高温警告温度	1.0—30.0	10.0	℃/F	相对于设定温度
	F16	低温警告温度	1.0—30.0	15.0	℃/F	相对于设定温度
	F17	室温超高警告温度	0—80.0	45.0	℃/F	
	F19	温度传感器修正	-20—20.0	0.0	℃/F	校正温度传感器误差
压机类	F21	压缩机停机保护时间	0—10	3	分钟	
	F29	控制模式	0/1	1	-	0: 恒温模式 1: 智能模式
告警类	F57	告警输出模式	0—1	0	-	0: 常开, 告警时闭合 1: 常闭, 告警时断开
系统设置类	F80	口令	OFF 0001—9999	OFF	-	OFF表示无口令 设置成0000表示清除口令
	F81	温度单位	C/F	C	-	C: 摄氏 F: 华氏
测试类	F98	厂家保留				
	F99	自检				此功能会依次吸合所有继电器, 严禁在线使用
	End	退出设置				

流量报警与输出端口

为了保证在冷却水循环出现异常情况时不影响设备的安全，CW-5000/5200系列冷水机特有低流量报警保护功能。

1、流量报警与输出端口及接线示意图

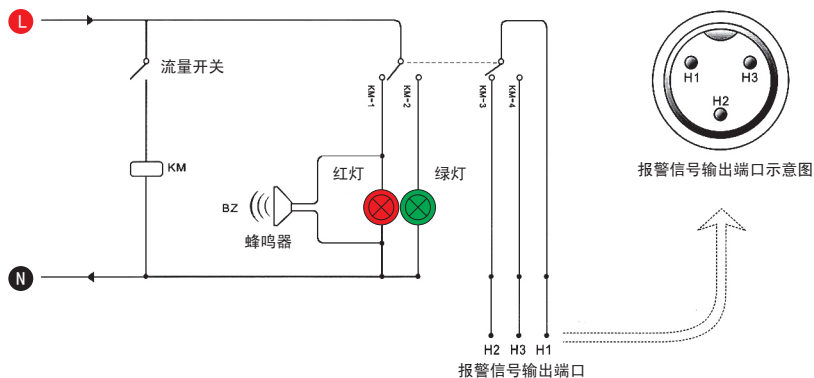

2、循环冷却水流量报警远离与工作状态表

系统指示 / 工作状态	流量正常指示灯	流量报警指示灯	蜂鸣器	输出端口 H1、H2	输出端口 H1、H3
循环泵工作正常	● 发光	⊗ 熄灭	⊗ 不发声	⊖ 断路	⊕ 导通
冷却水循环回路堵塞	⊗ 熄灭	● 发光	⊙ 发声	⊕ 导通	⊖ 断路
缺水报警	⊗ 熄灭	● 发光	⊙ 发声	⊕ 导通	⊖ 断路
循环水泵故障	⊗ 熄灭	● 发光	⊙ 发声	⊕ 导通	⊖ 断路
冷却水供电中断				⊕ 导通	⊖ 断路

注：流量报警端口连接机内继电器一组常开、常闭触点。要求工作电流小于5A，工作电压小于300V。

PARTS INTRODUCTION

FRONT

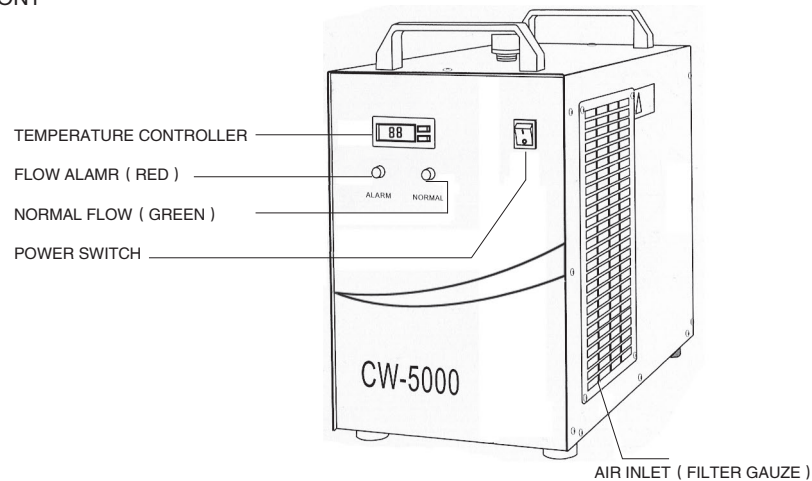

BACK

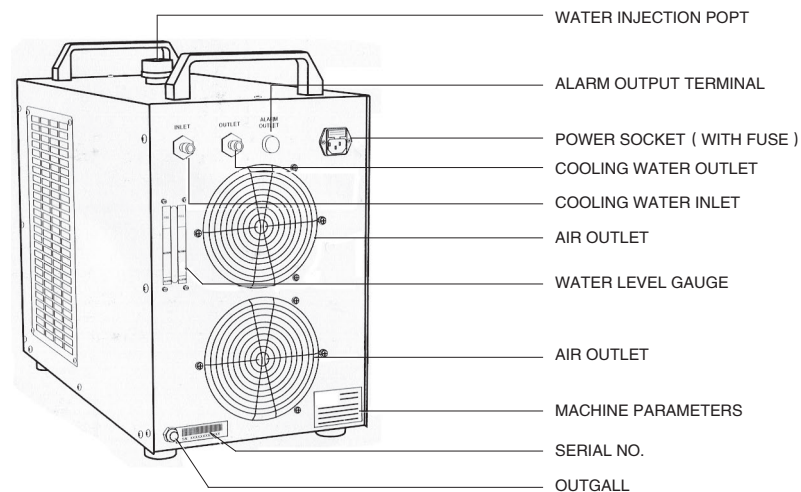

技术参数

CW-5000 参数表

型号	CW-5000AG	CW-5000BG	CW-5000DG	CW-5000AI	CW-5000BI	CW-5000DI	CW-5000AK	CW-5000BK	CW-5000DK
工作电压	AC220 ~ 240V	AC208 ~ 230V	AC100 ~ 110V	AC220 ~ 240V	AC208 ~ 230V	AC100 ~ 110V	AC220 ~ 240V	AC208 ~ 230V	AC100 ~ 110V
工作频率	50Hz	60Hz	60Hz	50Hz	60Hz	60Hz	50Hz	60Hz	60Hz
工作电流	1.4 ~ 2.1A		3.5 ~ 5.6A	1.4 ~ 2.1A		3.5 ~ 5.6A	1.4 ~ 2.1A		3.5 ~ 5.6A
压缩机功率	0.295KW 0.40HP	0.38KW 0.52HP	0.305KW 0.41HP	0.295KW 0.40HP	0.38KW 0.52HP	0.305KW 0.41HP	0.295KW 0.40HP	0.38KW 0.52HP	0.305KW 0.41HP
制冷量	2361Btu/h	2999Btu/h	2866Btu/h	2361Btu/h	2999Btu/h	2866Btu/h	2361Btu/h	2999Btu/h	2866Btu/h
	0.692KW	0.879KW	0.84KW	0.692KW	0.879KW	0.84KW	0.692KW	0.879KW	0.84KW
	595Kcal/h	756Kcal/h	722Kcal/h	595Kcal/h	756Kcal/h	722Kcal/h	595Kcal/h	756Kcal/h	722Kcal/h
制冷剂	R-134a								
充注量	300g	320g	280g	300g	320g	280g	300g	320g	280g
温控精度	±0.3℃								
节流器	毛细管								
安全保护	压缩机过流保护, 流量报警, 超温报警								
水泵功率	0.03KW			0.1KW			0.05KW		
水箱容量	6L								
出入口	外径10mm铜咀						直径8mm快速接头		
最大扬程	10M			25M			70M		
最大流量	10L/min			16L/min			2L/min		
净重	26Kgs								
毛重	31Kgs								
机器尺寸	55 × 28 × 43cm(长 × 宽 × 高)								
包装尺寸	72 × 44 × 62cm(长 × 宽 × 高)								

CW-5200 参数表

*有加热和更高温控精度的功能可供选择。

型号	CW-5200AG	CW-5200BG	CW-5200DG	CW-5200AI	CW-5200BI	CW-5200DI	CW-5200AK	CW-5200BK	CW-5200DK
工作电压	AC220 ~ 240V	AC208 ~ 230V	AC100 ~ 110V	AC220 ~ 240V	AC208 ~ 230V	AC100 ~ 110V	AC220 ~ 240V	AC208 ~ 230V	AC100 ~ 110V
工作频率	50Hz	60Hz	60Hz	50Hz	60Hz	60Hz	50Hz	60Hz	60Hz
工作电流	2.4 ~ 3.1A	2.6 ~ 3.3A	4.5 ~ 6.5A	2.4 ~ 3.1A	2.6 ~ 3.3A	4.5 ~ 6.5A	2.4 ~ 3.1A	2.6 ~ 3.3A	4.5 ~ 6.5A
压缩机功率	0.52KW 0.71HP	0.5KW 0.68HP	0.68KW 0.93HP	0.52KW 0.71HP	0.5KW 0.68HP	0.68KW 0.93HP	0.52KW 0.71HP	0.5KW 0.68HP	0.68KW 0.93HP
制冷量	5084Btu/h	4982Btu/h	5186Btu/h	5084Btu/h	4982Btu/h	5186Btu/h	5084Btu/h	4982Btu/h	5186Btu/h
	1.49KW	1.46KW	1.52KW	1.49KW	1.46KW	1.52KW	1.49KW	1.46KW	1.52KW
	1281Kcal/h	1256Kcal/h	1307Kcal/h	1281Kcal/h	1256Kcal/h	1307Kcal/h	1281Kcal/h	1256Kcal/h	1307Kcal/h
制冷剂	R-22/R134a/r-410a								
充注量	360g	380g	350g	360g	380g	350g	360g	380g	350g
温控精度	±0.3℃								
节流器	毛细管								
安全保护	压缩机过流保护, 流量报警, 超温报警								
水泵功率	0.03KW			0.1KW			0.05KW		
水箱容量	6L								
出入口	外径10mm铜咀						直径8mm快速接头		
最大扬程	10M			25M			70M		
最大流量	10L/min			16L/min			2L/min		
净重	30Kgs								
毛重	35Kgs								
机器尺寸	55 × 28 × 43cm(长 × 宽 × 高)								
包装尺寸	72 × 44 × 62cm(长 × 宽 × 高)								

*有加热和更高温控精度的功能可供选择。

Please read the installation instructions carefully before installing and operating and keep it properly.

This installation instructions is not a quality assurance.Manufacturer reserves the right to the interpretation of correction of typographical errors,improper mentioned information and product improvement.

The amended content will be reprinted in installation instructions without notice in advance.

CAUTIONS

- 1 Please ensure that the power supply and electrical outlet are in good contact and the earth wire must be firmly grounded!

Although the average operating current of the chiller is small,but the instantaneous operating current could be up to 6~10amps sometimes (The instantaneous operating current of models of AC110V power supply are possible to be up to 10~15 amps).

- 2 Please make sure there is a stable and normal voltage for the working chiller!

As the refrigeration compressor is more sensitive to the power supply and voltage,so the operating voltage of our standard product is of 200 ~ 250V (110model is of 100 ~ 130V).If you do need a wide roperating voltage range,customization is available for us.

- 3 Unmatched power frequency can cause the chiller damage!

Please choose model of 50 Hz or 60 Hz according to actual circumstance.

- 4 To protect the pump,it's strictly forbidden to run the chiller without having water in the storage water tank!

The new machine is packed after draining whole water in the tank,so please make sure the tank has enough water inside before machine starting,otherwise it's easily to have the pump damaged. When the water level is below the green(NORMAL)range of the water level gauge, the cooling capacity of our chiller will go down slightly Hence please ensure the water level is within the green(NORMAL)range.To drain through circulating pump is strictly prohibited!

- 5 Please be sure that the air inlet and air outlet are in good ventilation!

There must be at least 30cm from obstructions to the air outlet which is in the back of the cooler,and should leave at least 8cm between obstructions and the side air inlet.

- 6 The filter screen must be regularly cleaned!

It's essential to unpick and wash the dust gauze,or the serious blockage will cause breakdown to the chiller.

- 7 Please pay attention to the effect of the condensate water!

With greater ambient humidity,when the water temperature is lower than the ambient temperature,the condensate water will generate on the surface of water circular pipes and the cooled components. If above circumstance appears,it is recommended to set a higher water temperature or keep connected pipes and cooled parts warm.



CAUTION: the appliance is not to be used by children or persons with reduced physical, sensory or mental capabilities,or lack of experience and knowledge.unless they have been given supervision or instruction,children being supervised not to play with the appliance!

简单故障处理

故障现象	故障原因	处理方法
开机不通电	电源线接触不好	检查电源接口，电源线插头是否接插到位，接触良好
	保险管熔断	拉出机器上电源接口中的保险管盒，检查保险管，必要时换上备用保险管，并检查电源电压是否稳定，检查电源接口，电源线插头是否接插到位，接触良好
流量报警（面板红灯亮） 用水管直接连接出水口、入水口没有水流	储水箱水位太低	检查水位计显示窗，加水到水位显示的绿色区域；并检查水循环管路有无漏水
与设备连接使用时流量报警（面板红灯亮），但用水管直接连接出水口、入水口时有水流、不报警	水循环管路有堵塞或水管折弯变形	检查水循环管路
水温超高报警	防尘网堵塞，散热不良	定期拆下防尘网清洗
	出风口或入风口通风不良	保证出、入风口通风顺畅
	电压严重偏低或者不稳定	改善供电线路或使用稳压器
	温控器参数设置不当	重新设定控制参数或恢复出厂设置
	冷却机频繁开关机	保证冷水机有足够的制冷时间（五分钟以上）
	热负荷超标	降低热负荷，或选用更大制冷量的机型
室温超高报警	冷水机使用环境温度偏高	改善通风，保证冷水机运行环境在40度以下
冷凝水凝结现象严重	水温低于环境温度较多，湿度大	调高水温或给管路保温
换水时排水口排水缓慢	注水口没有打开	打开注水口

装箱清单

- 工业循环冷水机一台
- 使用说明书一份
- 电源线一条
- 连接软管一条
- 密封箍两个
- 报警信号输出端插头一个
- 备用保险管一个
(装在电源接口备用保险管座内)

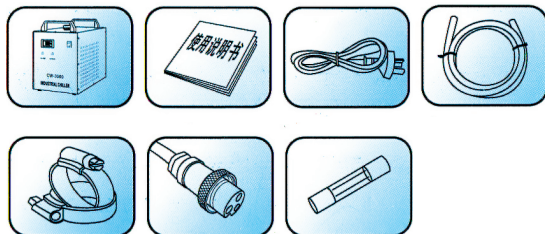

Contents

Cautions	12
Parts introduction	13
Installation	14
Operation and parameters adjustment	15
Flow alarm and output ports	19
Specifications	20
Simple troubleshooting	21